

## General Description

SFGMOS<sup>®</sup> MOSFET is based on Oriental Semiconductor's unique device design to achieve low  $R_{DS(ON)}$ , low gate charge, fast switching and excellent avalanche characteristics. The low  $V_{th}$  series is specially designed to use in synchronous rectification power systems with low driving voltage.

## Features

- Low  $R_{DS(ON)}$  & FOM
- Extremely low switching loss
- Excellent reliability and uniformity
- Fast switching and soft recovery



## Applications

- PD charger
- Motor driver
- Switching voltage regulator
- DC-DC convertor
- Switched mode power supply

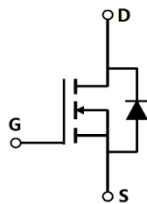
## Key Performance Parameters

Parameter	Value	Unit
$V_{DS, min} @ T_{j(max)}$	100	V
$I_{D, pulse}$	210	A
$R_{DS(ON) max} @ V_{GS}=10V$	10	m
$Q_g$	49.9	nC

## Marking Information

Product Name	Package	Marking
SFG10R10AF	TO251	SFG10R10

## Package & Pin information



**Absolute Maximum Ratings** at  $T_j=25^{\circ}\text{C}$  unless otherwise noted

Parameter	Symbol	Value	Unit
Drain source voltage	$V_{DS}$	100	V
Gate source voltage	$V_{GS}$	$\pm 20$	V
Continuous drain current <sup>1)</sup> , $T_C=25^{\circ}\text{C}$	$I_D$	70	A
Pulsed drain current <sup>2)</sup> , $T_C=25^{\circ}\text{C}$	$I_{D, pulse}$	210	A
Continuous diode forward current <sup>1)</sup> , $T_C=25^{\circ}\text{C}$	$I_S$	70	A
Diode pulsed current <sup>2)</sup> , $T_C=25^{\circ}\text{C}$	$I_{S, Pulse}$	210	A
Power dissipation <sup>3)</sup> , $T_C=25^{\circ}\text{C}$	$P_D$	125	W
Single pulsed avalanche energy <sup>5)</sup>	$E_{AS}$	100	mJ
Operation and storage temperature	$T_{stg}$ $T_j$	-55 to 150	$^{\circ}\text{C}$

**Thermal Characteristics**

Parameter	Symbol	Value	Unit
Thermal resistance, junction-case	$R_{JC}$	1	$^{\circ}\text{C}/\text{W}$
Thermal resistance, junction-ambient <sup>4)</sup>	$R_{JA}$	62	$^{\circ}\text{C}/\text{W}$

**Electrical Characteristics** at  $T_j=25^{\circ}\text{C}$  unless otherwise specified

Parameter	Symbol	Min.	Typ.	Max.	Unit	Test condition
Drain-source breakdown voltage	$BV_{DSS}$	100			V	$V_{GS}=0\text{ V}$ , $I_D=250\ \mu\text{A}$
Gate threshold voltage	$V_{GS(th)}$	1.0		2.5	V	$V_{DS}=V_{GS}$ , $I_D=250\ \mu\text{A}$
Drain-source on-state resistance	$R_{DS(ON)}$		8.5	10.0	m	$V_{GS}=10\text{ V}$ , $I_D=10\text{ A}$
Drain-source on-state resistance	$R_{DS(ON)}$		9.5	12.0	m	$V_{GS}=4.5\text{ V}$ , $I_D=10\text{ A}$
Gate-source leakage current	$I_{GSS}$			100		

### Dynamic Characteristics

Parameter	Symbol	Min.	Typ.	Max.	Unit	Test condition
Input capacitance	$C_{iss}$		2604		pF	$V_{GS}=0\text{ V}$ , $V_{DS}=50\text{ V}$ , $f=1\text{ MHz}$
Output capacitance	$C_{oss}$		361		pF	
Reverse transfer capacitance	$C_{rss}$		6.5		pF	
Turn-on delay time	$t_{d(on)}$		20.6		ns	$V_{GS}=10\text{ V}$ , $V_{DS}=50\text{ V}$ , $R_G=2.2\ \Omega$ , $I_D=25\text{ A}$
Rise time	$t_r$		5		ns	
Turn-off delay time	$t_{d(off)}$		51.8		ns	
Fall time	$t_f$		9		ns	

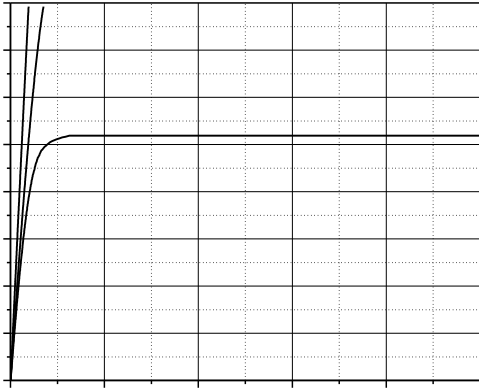
### Gate Charge Characteristics

Parameter	Symbol	Min.	Typ.	Max.	Unit	Test condition
Total gate charge	$Q_g$		49.9		nC	$V_{GS}=10\text{ V}$ , $V_{DS}=50\text{ V}$ , $I_D=25\text{ A}$
Gate-source charge	$Q_{gs}$		6.5		nC	
Gate-drain charge	$Q_{gd}$		12.4		nC	
Gate plateau voltage	$V_{plateau}$		3.4		V	

### Body Diode Characteristics

Parameter	Symbol	Min.	Typ.	Max.	Unit	Test condition
Diode forward voltage	$V_{SD}$			1.3	V	$I_S=12\text{ A}$ , $V_{GS}=0\text{ V}$
Reverse recovery time	$t_{rr}$		60.4		ns	$V_R=50\text{ V}$ ,

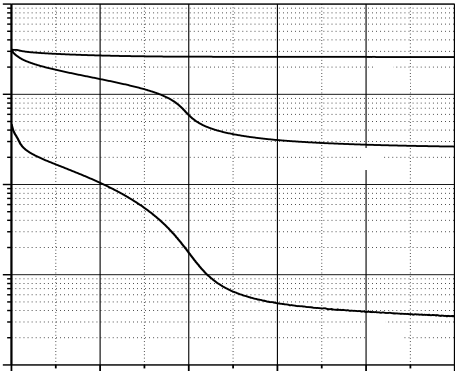
**Electrical Characteristics Diagrams**



**Figure 1. Typ. output characteristics**



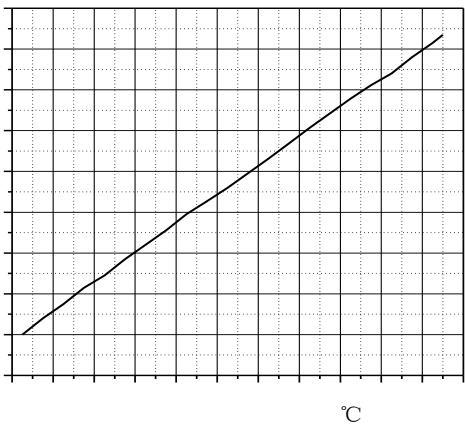
**Figure 2. Typ. transfer characteristics**



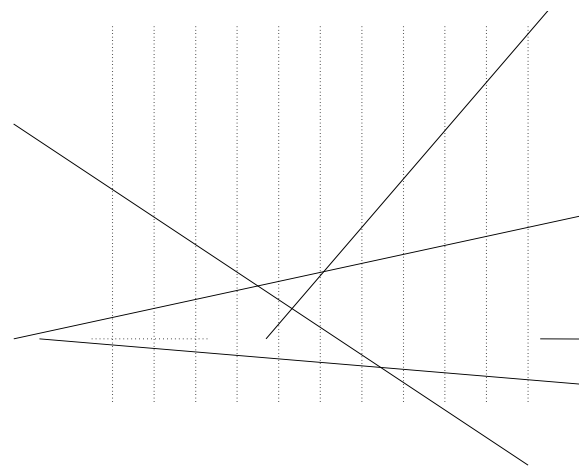
**Figure 3. Typ. capacitances**



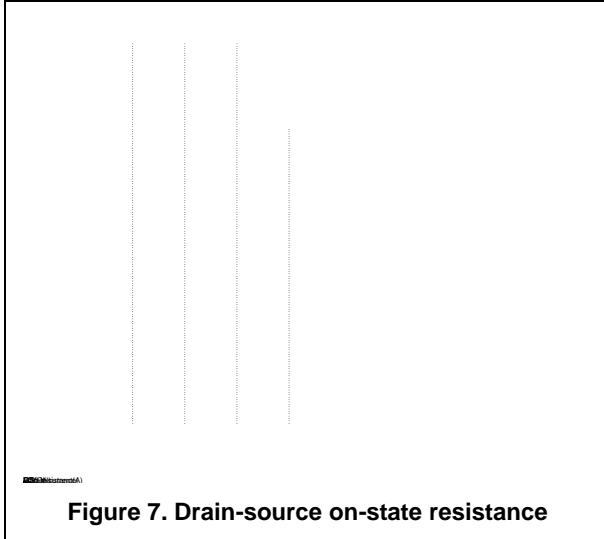
**Figure 4. Typ. gate charge**



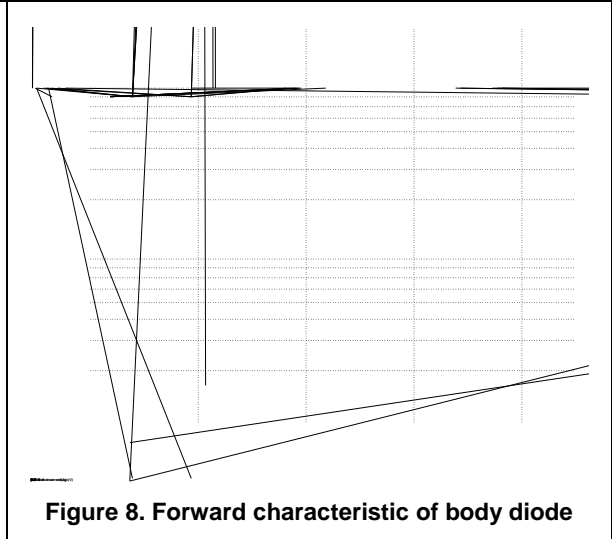
**Figure 5. Drain-source breakdown voltage**



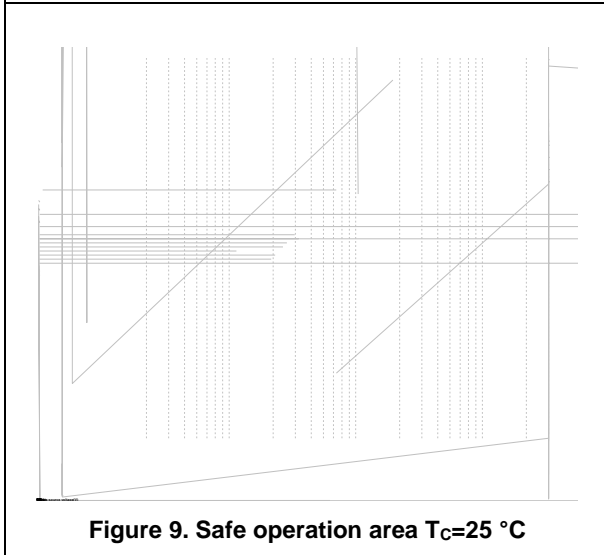
**Figure 6. Drain-source on-state resistance**



**Figure 7. Drain-source on-state resistance**

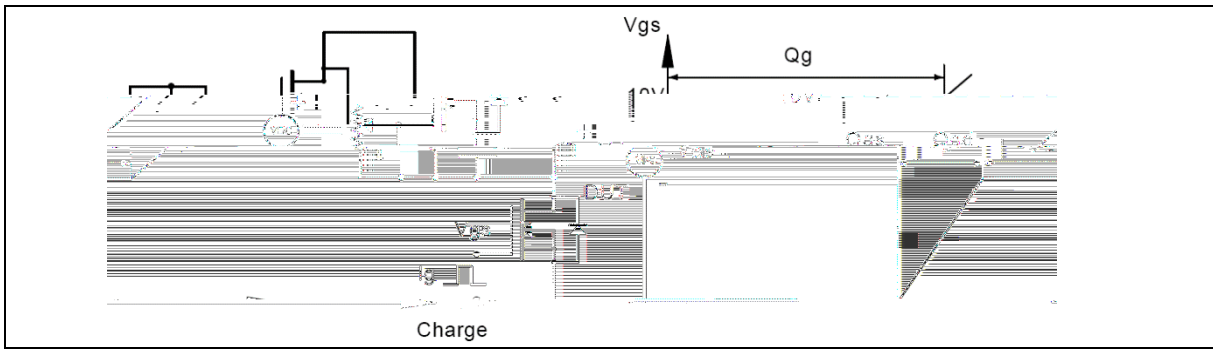


**Figure 8. Forward characteristic of body diode**

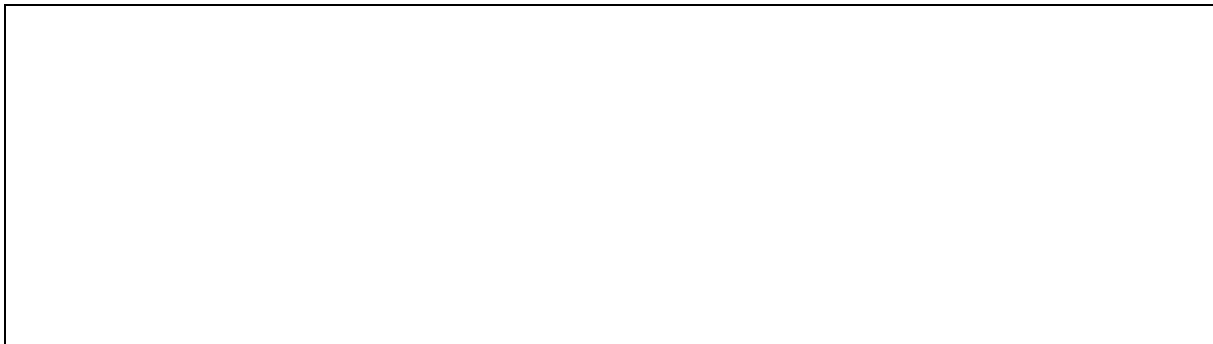


**Figure 9. Safe operation area  $T_C=25\text{ }^\circ\text{C}$**

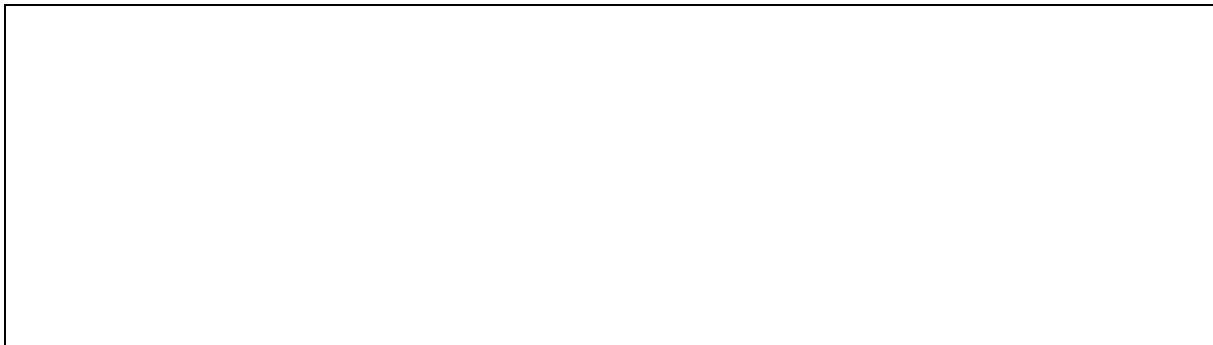
**Test circuits and waveforms**



**Figure 1. Gate charge test circuit & waveform**



**Figure 2. Switching time test circuit & waveforms**



**Figure 3. Unclamped inductive switching (UIS) test circuit & waveforms**

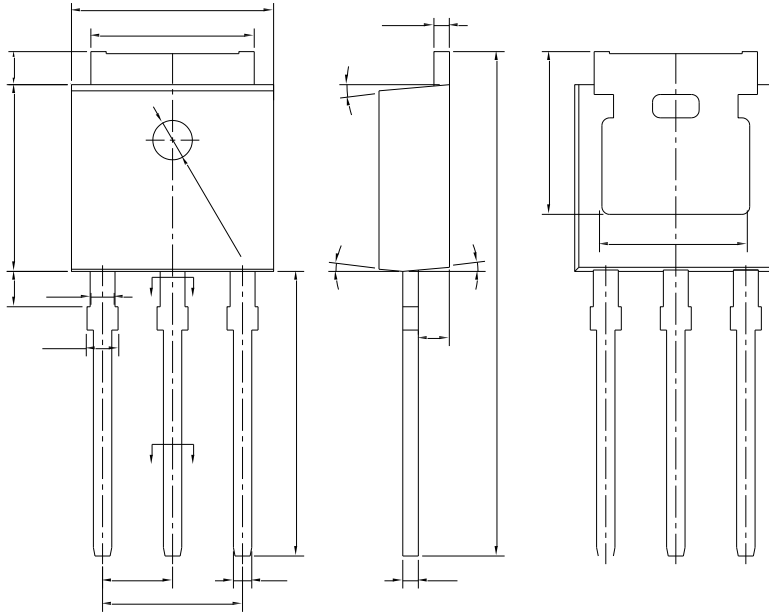


**Figure 4. Diode reverse recovery test circuit & waveforms**

## Package Information

Symbol	mm		
	Min	Nom	Max
A	2.20	2.30	2.40
A2	0.97	1.07	1.17
b	0.68	0.78	0.90
b2	0.00	0.04	0.10
b2'	0.00	0.04	0.10
b3	5.20	5.33	5.50
c	0.43	0.53	0.63
D	5.98	6.10	6.22
D1	5.30REF		
E	6.40	6.60	6.80
E1	4.63	-	-
e	2.286BSC		
H	16.22	16.52	16.82
L1			

**Package Information**



Symbol	mm		
	Min	Nom	Max
A	2.20	2.30	2.35
A1	0.90	1.01	1.10
b	0.56	-	0.69
b1	0.55	0.60	0.65
b2	0.77	-	0.90
b3	0.76	0.81	0.86
b4	5.23	5.33	5.43
b5	-	-	1.05
c	0.46	-	0.59
c1	0.45	0.51	0.55
c2	0.46	-	0.59
D	6.00	6.10	6.20
D1	5.20	-	-
E	6.50	6.60	6.70
E1	4.60	4.83	5.00
e	2.24	2.29	2.34
e1	4.47	4.57	4.67
H	16.18	16.48	16.78
L	9.00	9.30	9.60
L1	0.95	1.16	1.35
L2	0.90	1.08	1.25
1	3°	5°	7°
2	1°	3°	5°

Version 2: TO251-J package outline dimension



### Ordering Information

Package Type	Units/ Tube	Tubes / Inner Box	Units/ Inner Box	Inner Boxes/ Carton Box	Units/ Carton Box
TO251-C	75	66	4950	6	29700
TO251-J	75	60	4500	5	22500

### Product Information

Product	Package	Pb Free	RoHS	Halogen Free
SFG10R10AF	TO251	yes	yes	yes

### Legal Disclaimer

The information given in this document shall in no event be regarded as a guarantee of conditions or characteristics. With respect to any examples or hints given herein, any typical values stated herein and/or any information regarding the application of the device, Oriental Semiconductor hereby disclaims any and all warranties and liabilities of any kind, including without limitation, warranties of non-infringement of intellectual property rights of any third party.

For further information on technology, delivery terms and conditions and prices, please contact the Oriental Semiconductor sales representatives ([www.orientalsemi.com](http://www.orientalsemi.com)).

© Oriental Semiconductor Co.,Ltd. All Rights Reserved /