

V_{DS}			100	V
$R_{DS(on),typ}$	TO-263	$V_{GS}=10V$	8.7	$m\Omega$
$R_{DS(on),typ}$		$V_{GS}=4.5V$	10.7	$m\Omega$
$R_{DS(on),typ}$	TO-220	$V_{GS}=10V$	9.0	$m\Omega$
$R_{DS(on),typ}$		$V_{GS}=4.5V$	11	$m\Omega$
I_D (Silicon Limited)			73	A

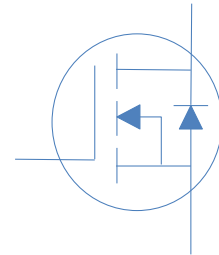
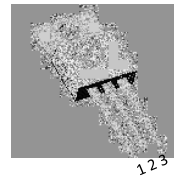

Part Number	Package	Marking
HGB110N10SL	TO-263	GB110N10SL
HGP110N10SL	TO-220	GP110N10SL

Absolute Maximum Ratings at T_J

Parameter	Symbol	Conditions	Value	Unit
Continuous Drain Current (Silicon Limited)	I_D	T_C	73	A
		T_C	52	
Drain to Source Voltage	V_{DS}	-	100	V
Gate to Source Voltage	V_{GS}	-	± 20	V
Pulsed Drain Current	I_{DM}	-	190	A
		A_S	$L=0.1mH, T_C$	
	P_D	T_C	125	W
Operating and Storage Temperature	T_J, T_{stg}	-	-55 to 175	

Absolute Maximum Ratings

Parameter	Symbol	Max	Unit
	$R_{\theta JA}$	50	
	$R_{\theta JC}$	1.2	

J

Parameter	Symbol	Conditions	Value			Unit
			min	typ	max	
	$V_{(BR)DSS}$	$V_{GS}=0V, I_D=250\mu A$	100	-	-	V
	V	$V_{GS}=V_{DS}, I_D=250\mu A$	1.4	1.9	2.4	
Zero Gate Voltage Drain Current	I_{DSS}	$V_{GS}=0V, V_{DS}=100V, T_j$	-	-	1	μA
		$V_{GS}=0V, V_{DS}=100V, T_j$	-	-	100	
Gate to Source Leakage Current	I_{GSS}	$V_{GS}=\pm 20V, V_{DS}=0V$	-	-	± 100	nA
Drain to Source on Resistance	$R_{DS(on)}$	$V_{GS}=10V, I_D=20A$ TO-263	-	8.7	10.7	m Ω
		$V_{GS}=4.5V, I_D=20A$ TO-263	-	10.7	13.7	
Drain to Source on Resistance	$R_{DS(on)}$	$V_{GS}=10V, I_D=20A$ TO-220	-	9	11	m Ω
		$V_{GS}=4.5V, I_D=20A$ TO-220	-	11	14	
Transconductance	g	$V_{DS}=5V, I_D=20A$	-	60	-	S
Gate Resistance	R_G	$V_{GS}=0V, V_{DS}$	-	1.5	-	Ω

Input Capacitance	C_{iss}		-	2275	-	
Output Capacitance	C_{oss}	$V_{GS}=0V, V_{DS}$	-	162	-	
	C_{rss}		-	7.9	-	
	$Q_g(10V)$	$V_{DD}=50V, I_D=14A, V_{GS}=10V$	-	29	-	nC
	$Q_g(4.5V)$		-	14	-	
	Q_{gs}		-	5	-	
	Q_{gd}		-	5	-	
Turn on Delay Time	$t_{d(on)}$		-	8	-	
Rise time	t_r	$V_{DD}=50V, I_D=14A, V_{GS}=10V,$ $R_G=10\Omega,$	-	3	-	ns
	t		-	26	-	
	t		-	4	-	

	V_{SD}	$V_{GS}=0V, I = 20A$	-	0.9	1.2	V
Reverse Recovery Time	t_{rr}	$V_R=50V, I = 12A, dl$	-	33	-	ns
	Q_{rr}		-	157	-	nC

--	--

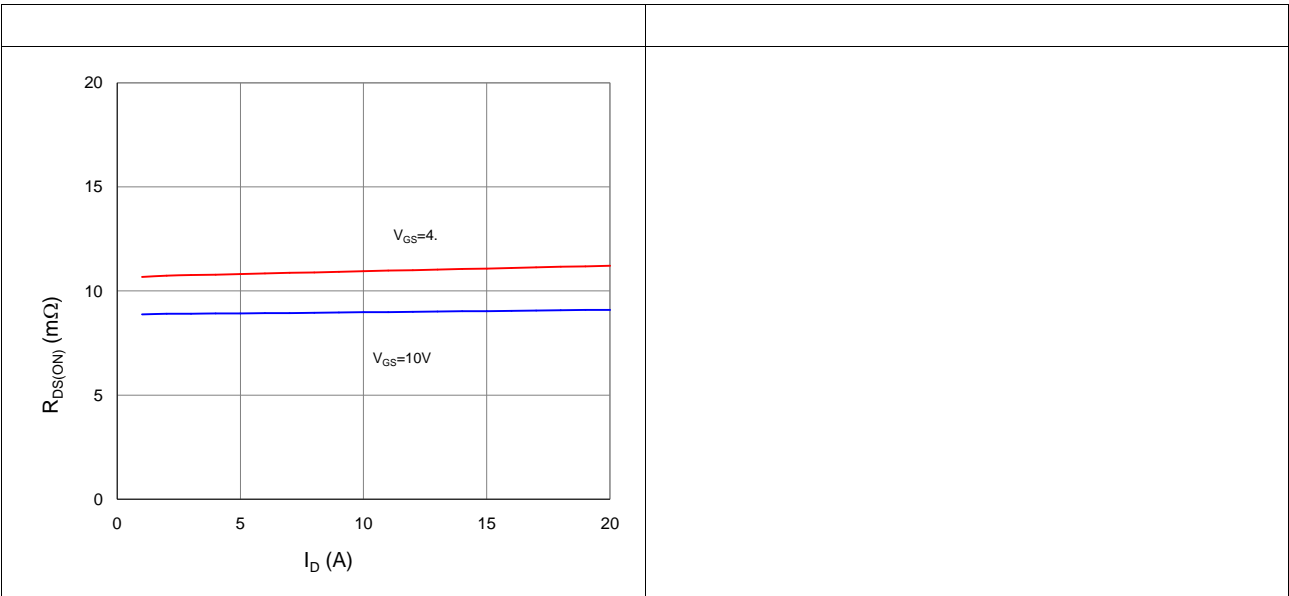

--	--

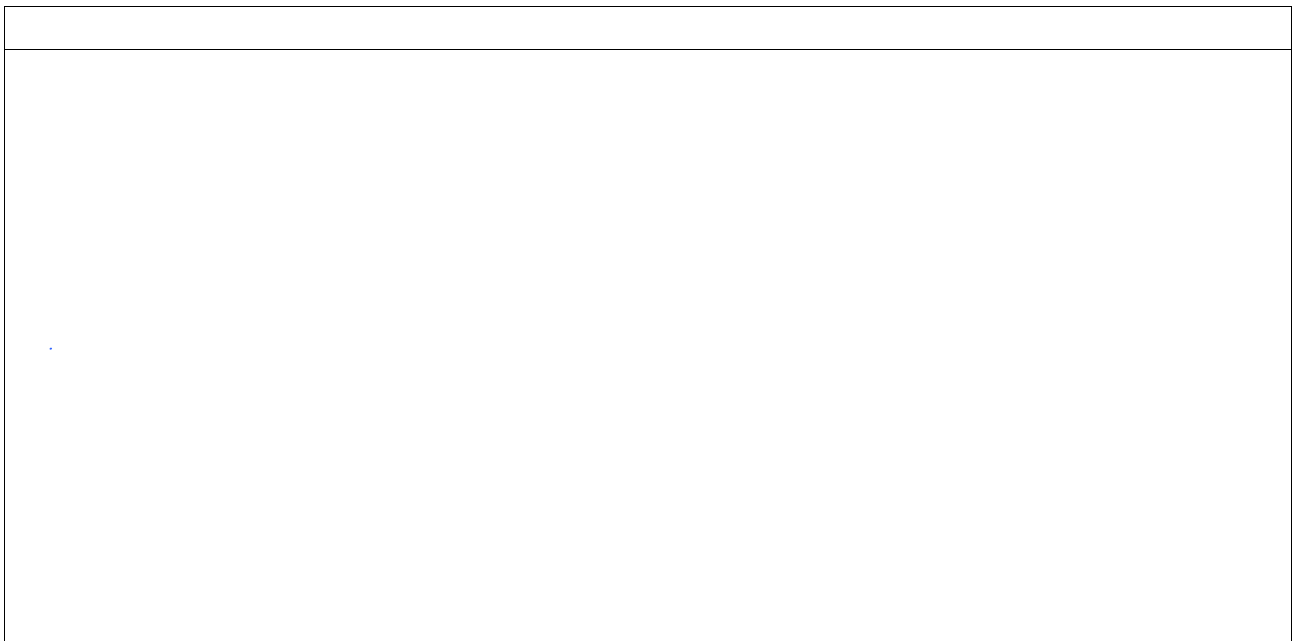
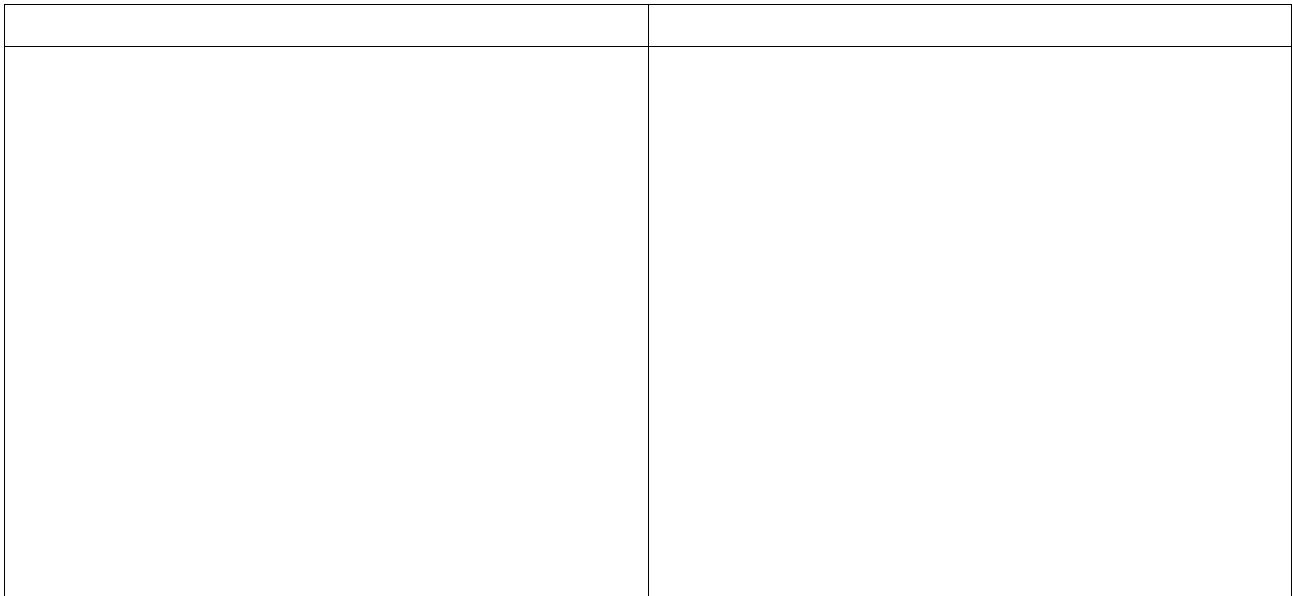
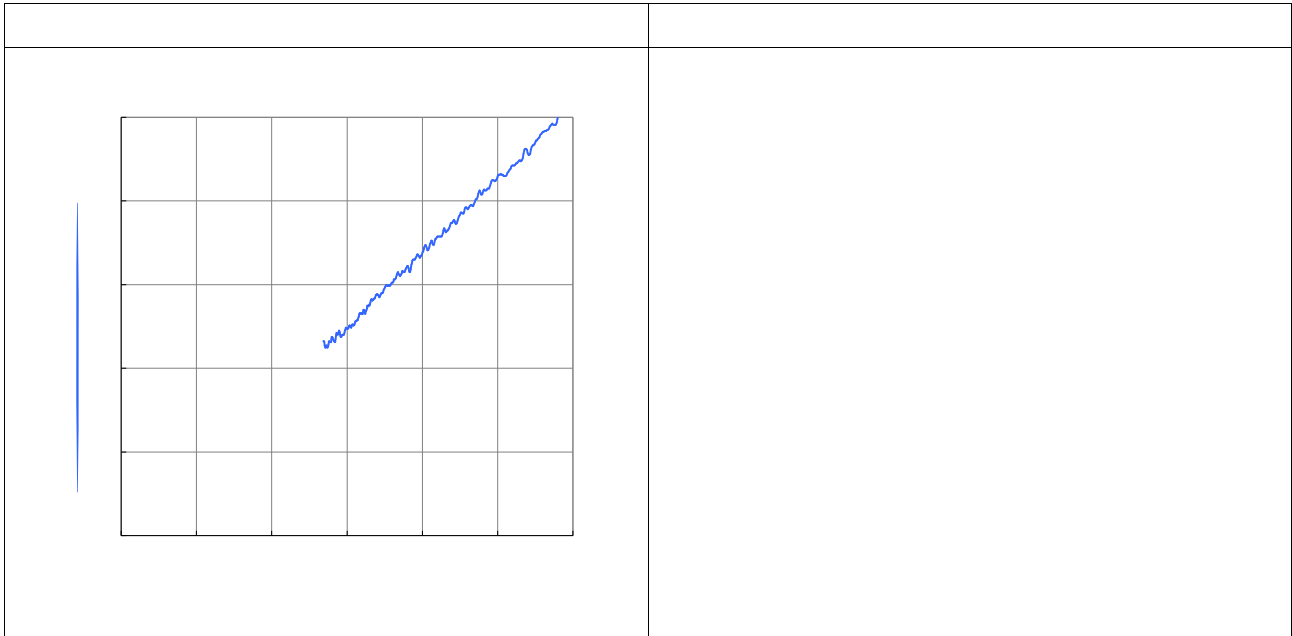

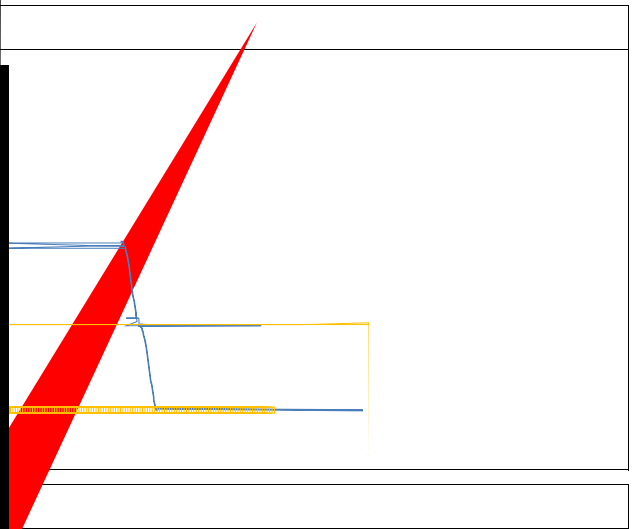

1

Package Outline

TO-220, 3 leads

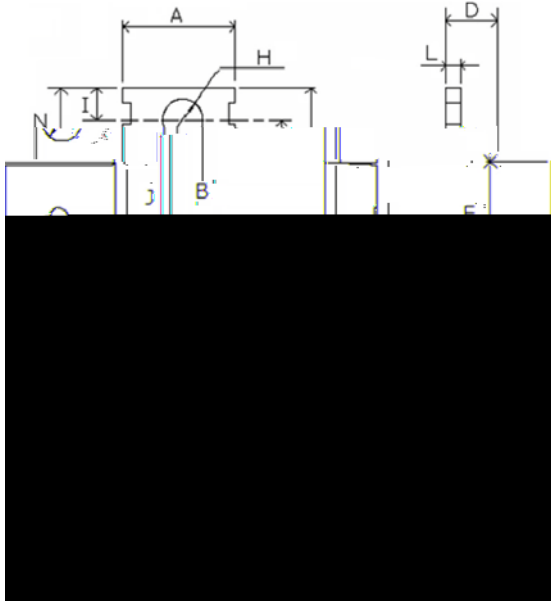

Symbol	Min	Nom	Max
A	9.66	9.97	10.28
A2	9.80	10.00	10.20
B	15.60	15.70	15.80
C	12.70	13.48	14.27
D	4.30	4.50	4.70
	9.00	9.20	9.40
		2.54	
G1	1.32	1.52	1.72
G2	0.70	0.82	0.95
G3	0.45	0.52	0.60
H	3.50	3.60	3.70
I	2.70	2.80	2.90
J	15.70	15.97	16.25
K	2.20	2.40	2.60
L	1.15	1.27	1.40
N	6.40	6.60	6.80

TO-263, 2 leads

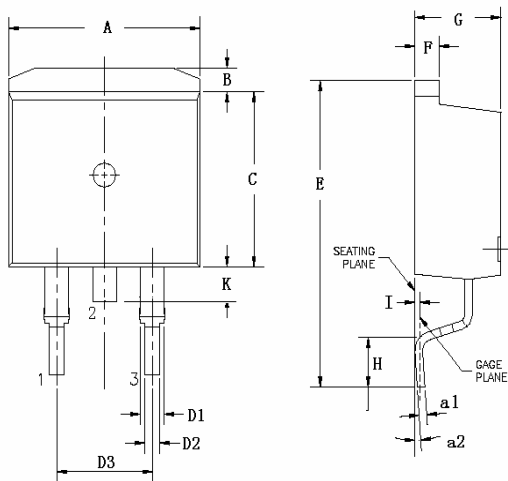

Symbol	Min	Nom	Max
A	9.66	9.97	10.28
B	1.02	1.17	1.32
C	8.59	9.00	9.40
D1	1.14	1.27	1.40
D2	0.70	0.83	0.95
D3		5.08	
	15.09	15.24	15.39
	1.15	1.28	1.40
G	4.30	4.50	4.70
H	2.29	2.54	2.79
I		0.25	
K	1.30	1.45	1.60
a1	0.45	0.55	0.65
a2(degree)	0°		8°