



**Feature**

- High Speed Power Switching, Logic Level
- Enhanced Body diode dv/dt capability
- Enhanced Avalanche Ruggedness
- 100% UIS Tested, 100% Rg Tested
- Lead Free, Halogen Free

			Ω
			Ω

**Application**

- Synchronous Rectification in SMPS
- Hard Switching and High Speed Circuit
- DC/DC in Telecoms and Industrial

DFN5x6

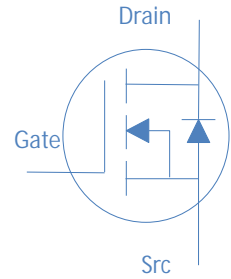

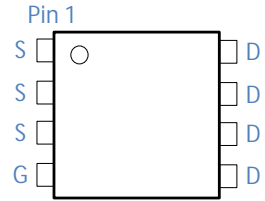
	θ		
	θ		



$\mu$

$\mu$

$\mu$

$\Omega$

$\Omega$

$\Omega$

$\mu$

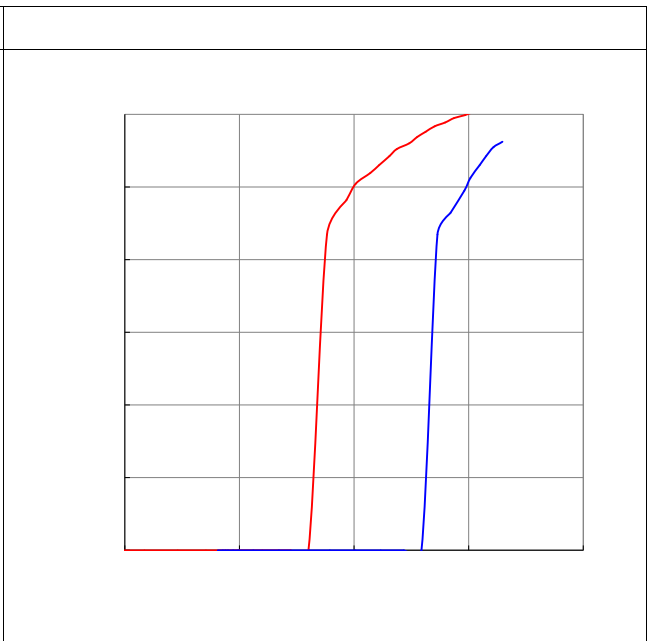
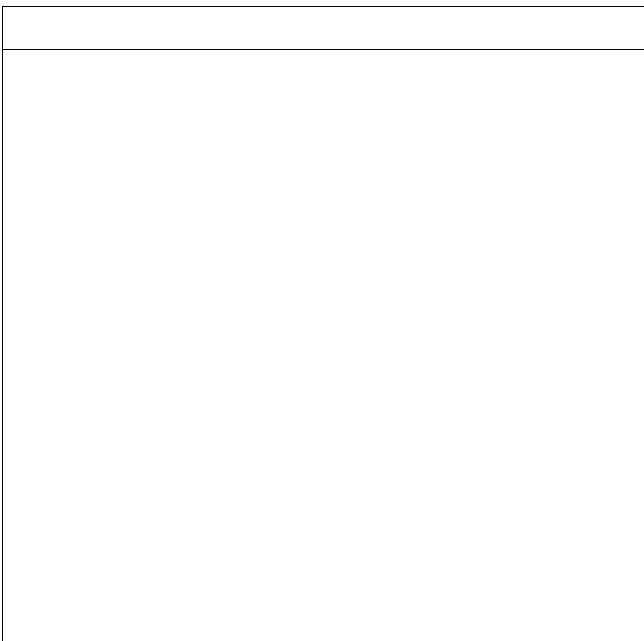
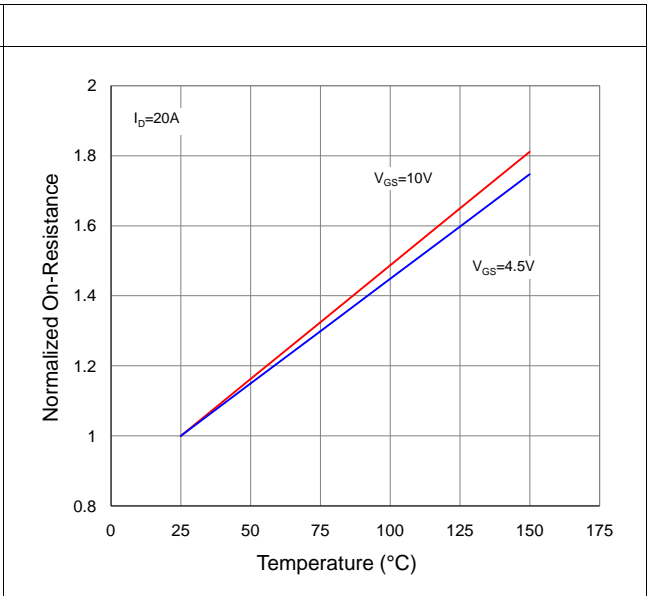
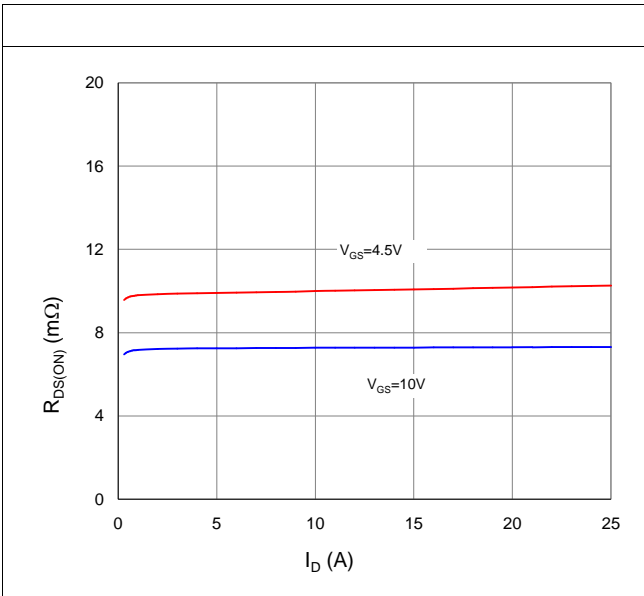
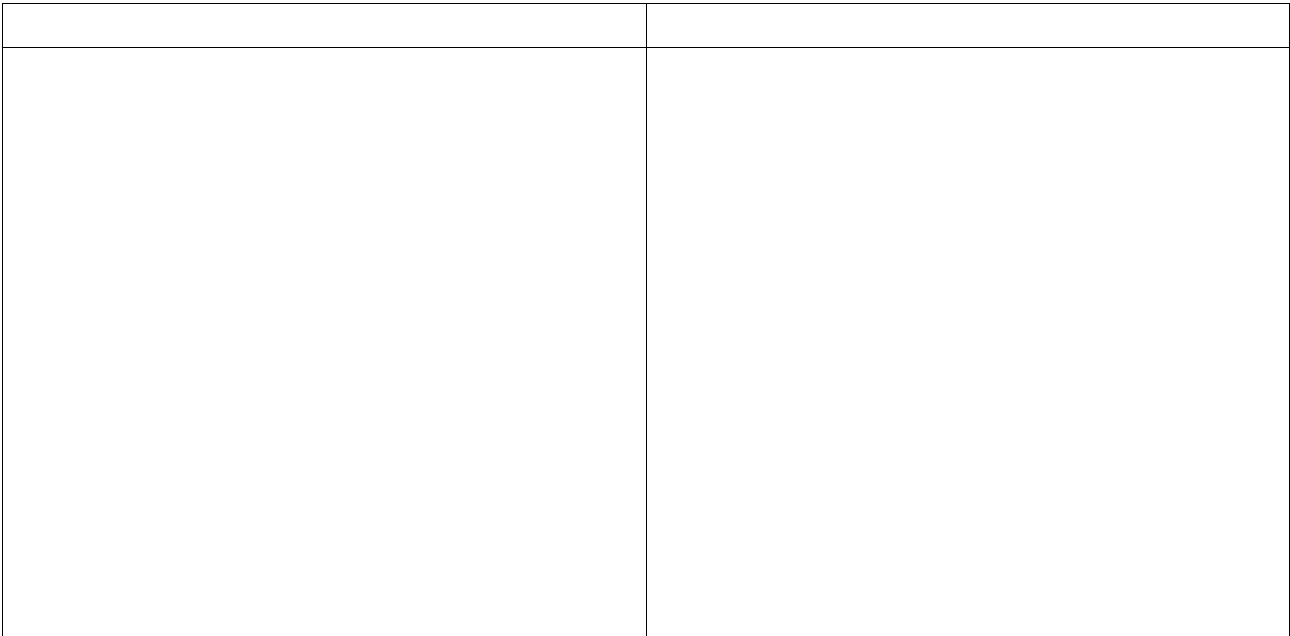

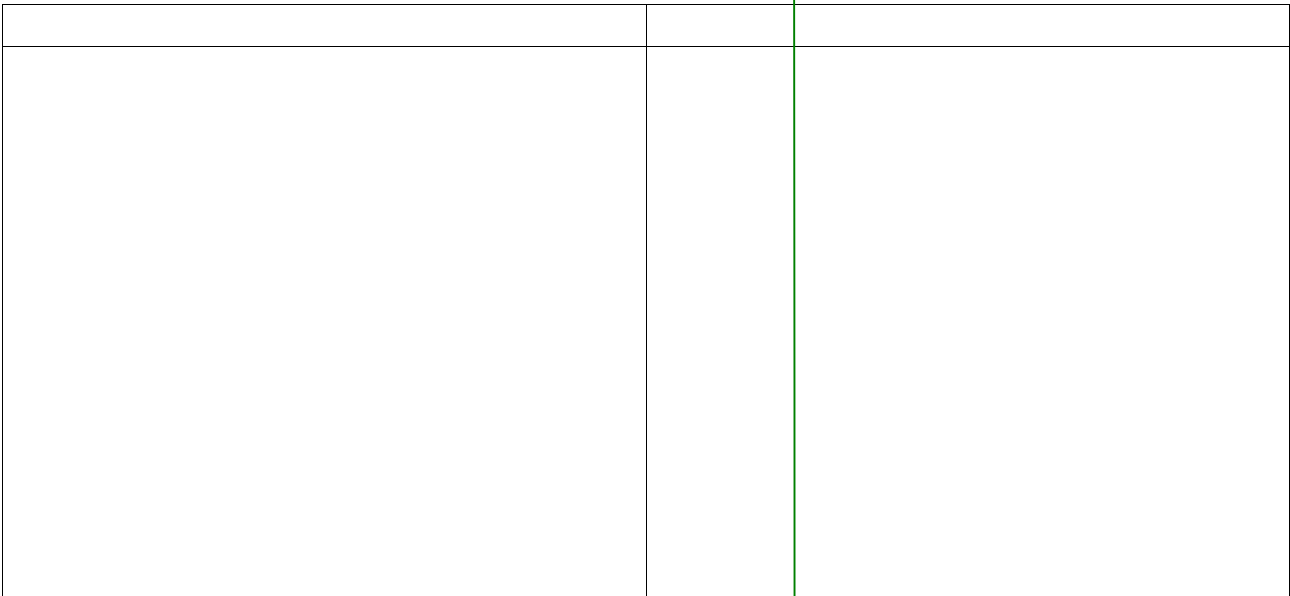
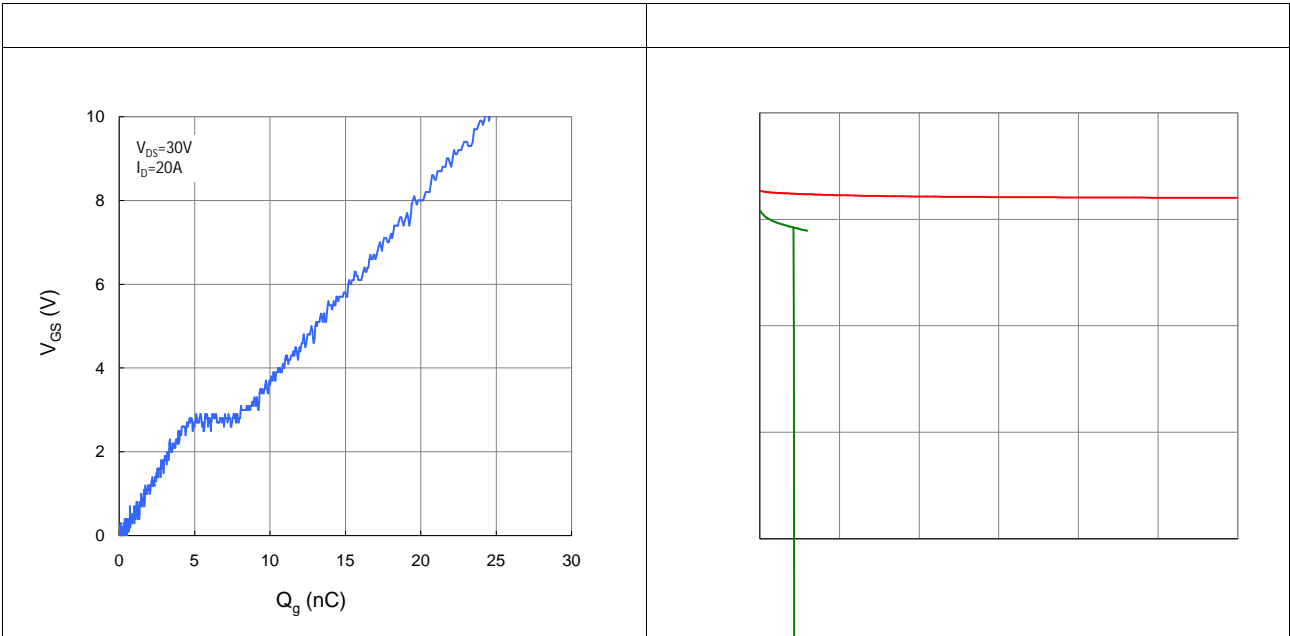



--	--

--	--

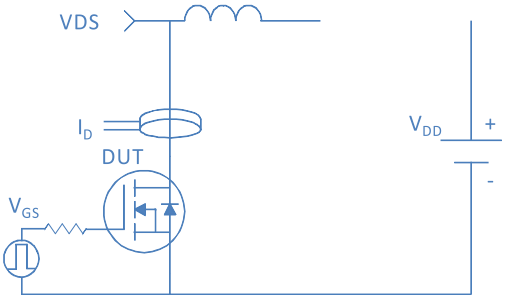
	
---	--

--	--

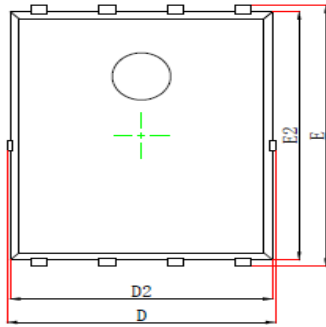

**Top View**  
[顶视图]

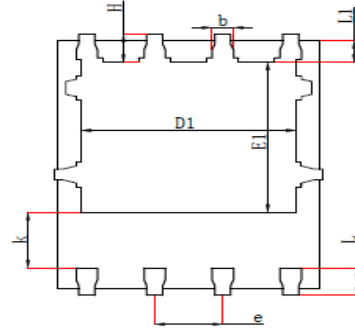

**Bottom View**  
[背视图]

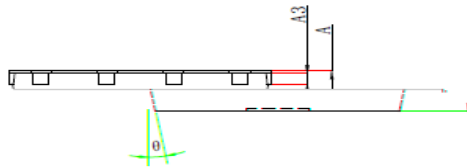

**Side View**  
[侧视图]

Symbol	Dimensions In Millimeters		Dimensions In Inches	
	Min	Max	Min	Max
A	0.900	1.100	0.035	0.043
A3	0.254 REF		0.010REF	
D	4.680	5.120	0.184	0.202
E	5.900	6.126	0.232	0.241
D1	3.610	4.110	0.142	0.162
E1	3.380	3.780	0.133	0.149
D2	4.800	5.000	0.189	0.197
E2	5.674	5.826	0.223	0.229
k	1.100	1.390	0.043	0.055
b	0.330	0.510	0.013	0.020
e	1.270TYP		1.270TYP	
L	0.510	0.711	0.020	0.028
L1	0.424	0.576	0.017	0.023
H	0.410	0.726	0.016	0.029
θ	0 <sup>0</sup>	12 <sup>0</sup>	0 <sup>0</sup>	12 <sup>0</sup>